

Post bracket M16/125

3D view

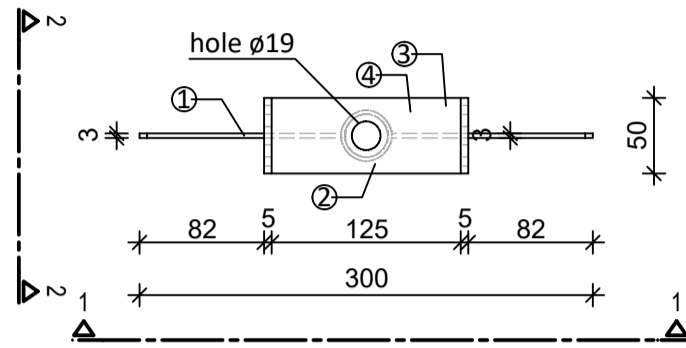

1 - 1

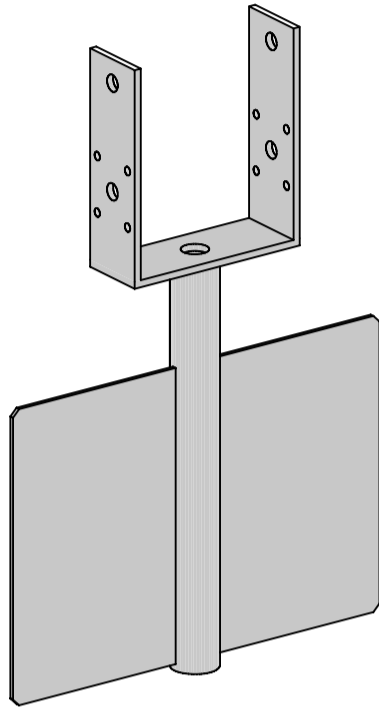
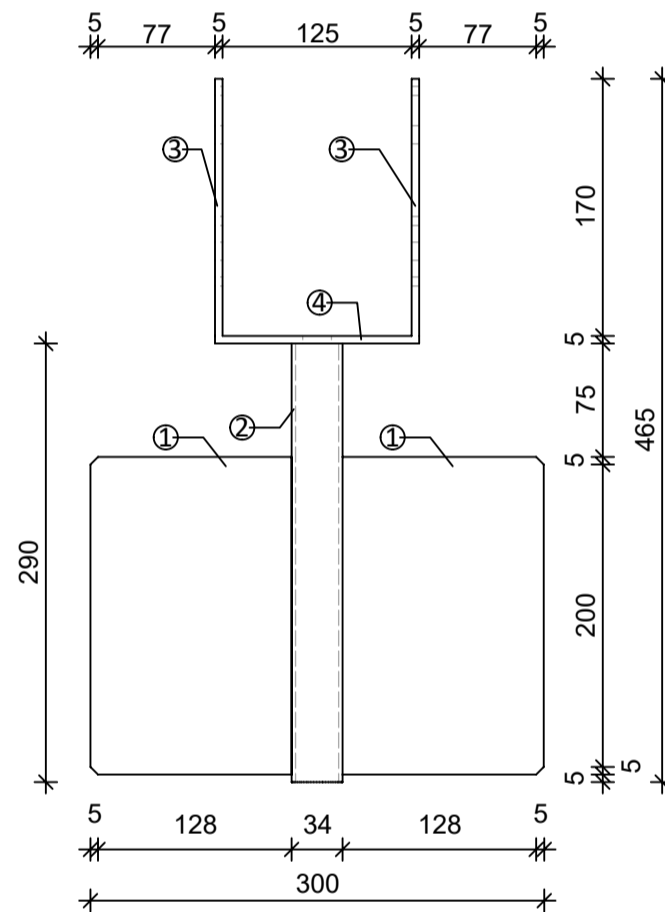

2 - 2

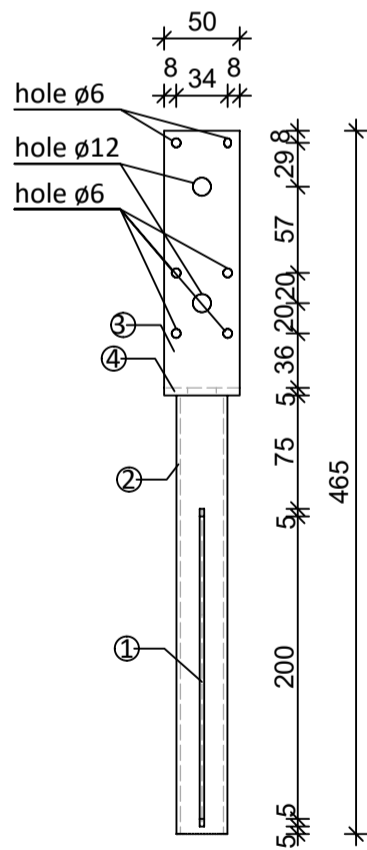

- ① Pl. 133x210x3
- ② CHS 33.7x2,6
- ③ Pl. 170x50x5
- ④ Pl. 135x50x5

Design company
GROUNDPLUG® CONFIDENTIAL

Part:	prod. draw.	Number of drawing:	PPT 7	Finish:	HDG acc. to ISO EN 1461	Date:	08.2020
Product/Title:	Post bracket M16/125	Material/Steel grade:	S235	Sub-grade:	-	Scale:	1:5
Design:		Signature:		Tolerances acc.to:	PN-EN ISO 9013: 2008	Format:	A3
Check:		Signature:			PN-EN ISO 13920: 2000		
Draw:		Signature:			EXC2		