

How to install the GroundPlug® Twister™ M16/1000mm screw pile foundation

NOTE: Before installing the screw pile foundations, it is important to ensure that there are no underlying cables or pipes in places where the screw pile foundations are to be installed.

Placement on the beams

1. Build your frame construction and level it out by support it with blocks and wedges
2. Place the GroundPlug® Twister™ screw piles foundations alternately on each side of your bearer. On the outer beams all the screw piles can be placed on the inside of the beam.
 - For single beam layer, mount the screw piles directly on your joists and outer beams
 - For double beam layer mount the screw piles on the bottom layer of bearers

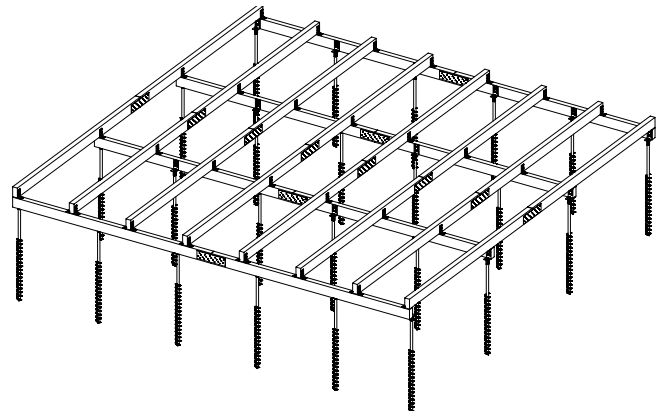

Mounting the GroundPlug® Twister™

1. The GroundPlug® Twister™ screw pile is best installed with a battery driven impact wrench with a 24mm top. Minimum torque: 1500Nm
Max distance from terrain to bottom of beams:
 - Decks: max 35 cm
 - Outbuildings up to 50m²: max 15 cm
2. The L-bracket is mounted with washer and bolt and fastened to the beam with screws (add bolts for vertical structures)

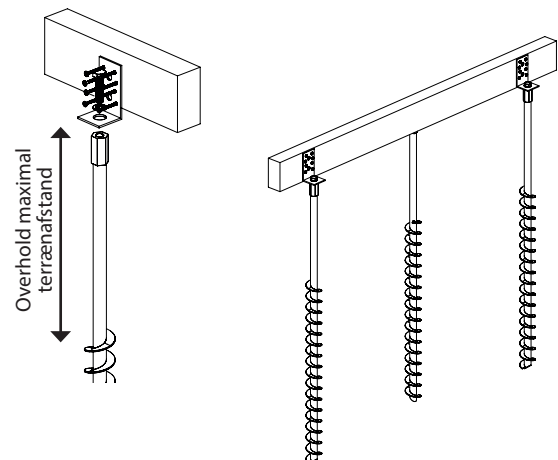

If you are mounting stabilisers

1. First install the screw piles
2. Next place the pipe of the stabiliser around the pipe of the screwpile and hammer it fully into the ground. Use a block between the hammer and the metal to protect the galvanisation. If you have very hard soil, use a spade before you mount the screwpile to make a vertical hole for the stabiliser
3. Finally mount the L-bracket as above

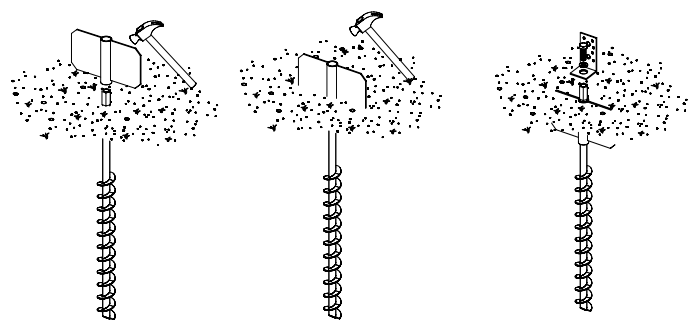

If you are uncertain about anything. Visit ems.groundplug.com for more info or contact us on shopau@groundplug.com