

Twister foundation  
M12 L=1000mm

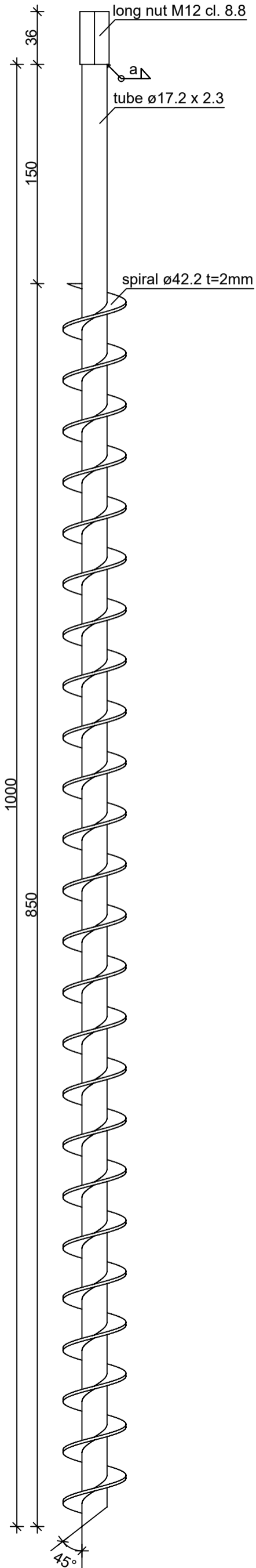

Twister foundation  
M12 L=750mm

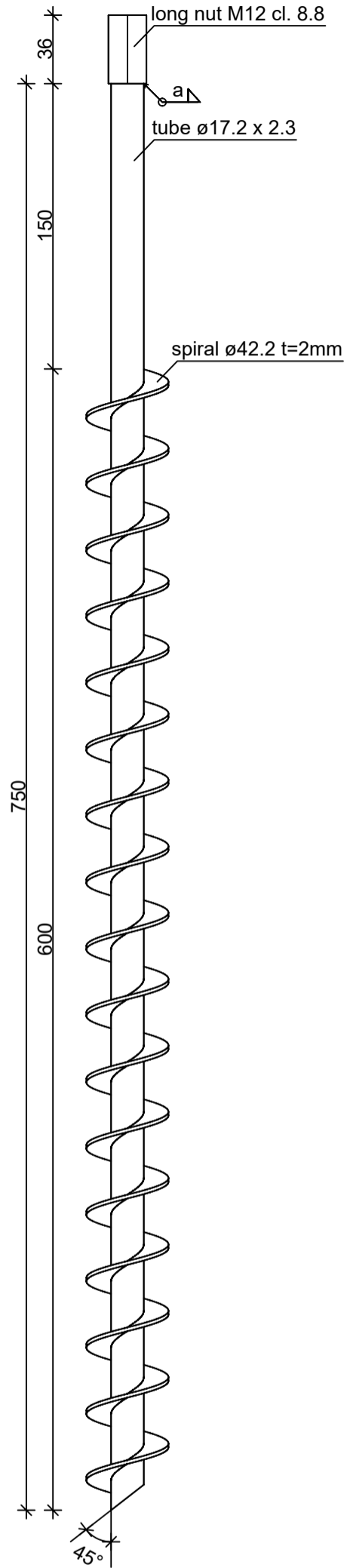

Twister foundation  
M12 L=600mm

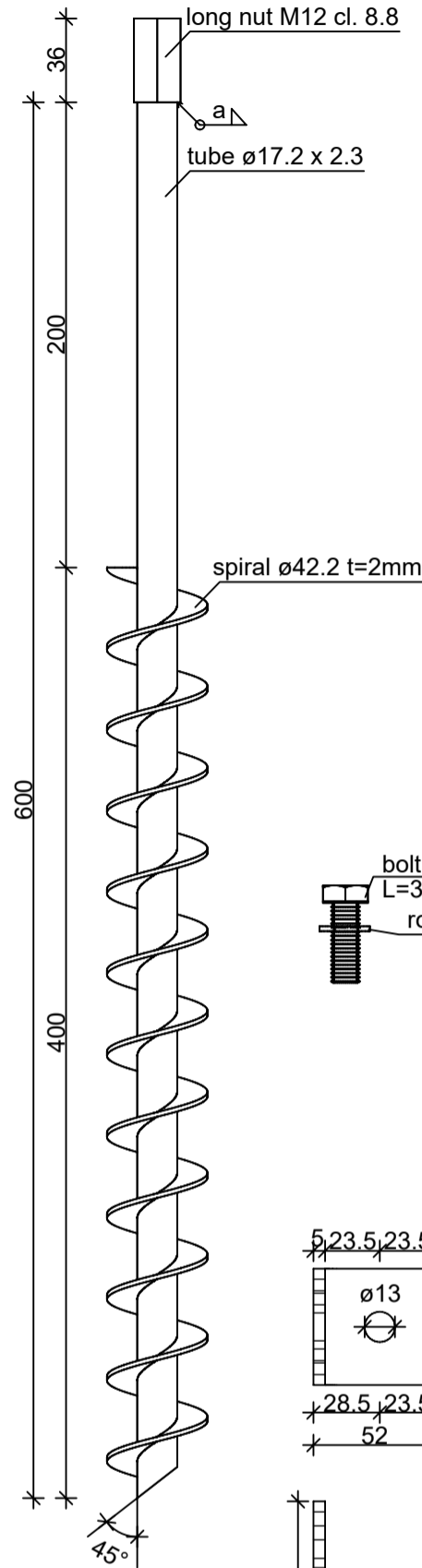

Extensioner  
M12 L=200mm

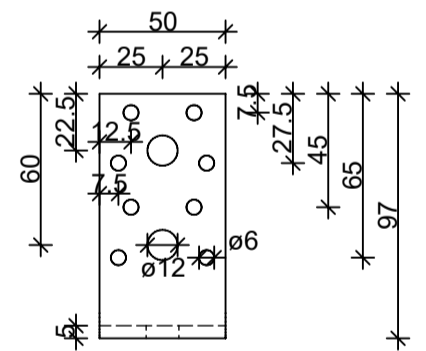
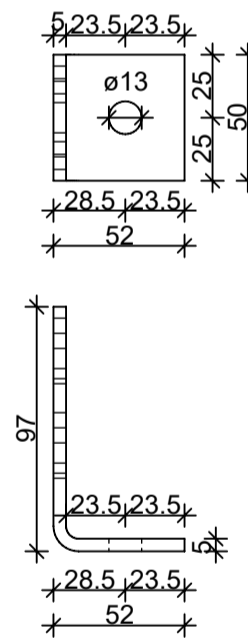
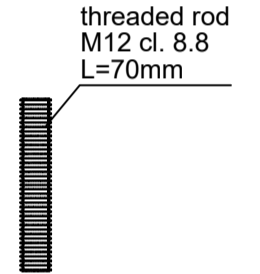
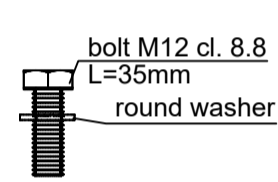
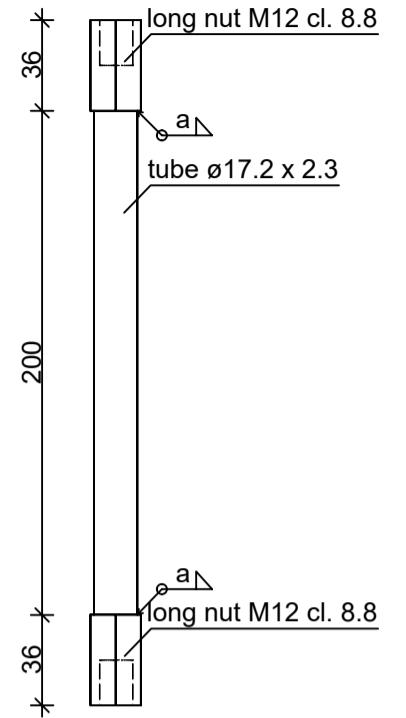

L-bracket made of steel S355

Design company				
<b>GROUNDPLUG®</b> CONFIDENTIAL				
Part:	prod. draw.	Number of drawing:	PPT 1 rev.1	Finish: HDG acc. to ISO EN 1461
Product/Title:	Twister foundation M12	Material/Steel grade:	S235	Date: 09.2020
Design:	Signature:	Sub-grade:	-	Scale: 1:3
Check:	Signature:	Tolerances acc.to:	PN-EN ISO 9013: 2008	Format: A3
Draw:	Signature:		PN-EN ISO 13920: 2000	
			EXC2	